

SEWER SHARK™

180

270

2K

99799

9770

ENERGY

SCORE

1K

900

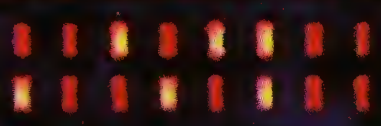

SONY

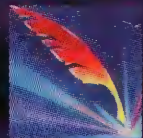

IMAGESOFT™



SEGA

TM

LICENSED BY SEGA OF AMERICA, INC.
FOR PLAY ON THE SEGA CD™ SYSTEM.



This official seal is your assurance that this product meets the highest quality standards of SEGA™. Buy games and accessories with this seal to be sure that they are compatible with the SEGA CD™ SYSTEM.

Handling Your CD Disc

- The Sega CD Disc is intended for use exclusively for the Sega CD System.
- Handle it with care. Do not bend it, crush it or submerge it in liquids.
- Do not leave it in direct sunlight or near a radiator or other source of heat.
- Be sure to take an occasional recess during extended play, to rest your self and the Sega CD Disc.

WARNING

For Owners of Projection Televisions:

Still pictures or images may cause permanent picture-tube damage or mark the phosphor of the CRT. Avoid repeated or extended use of video games on large screen projection televisions.

WARNING:

READ BEFORE USING YOUR SEGA VIDEO GAME SYSTEM

A very small percentage of individuals may experience epileptic seizures when exposed to certain light patterns or flashing lights. Exposure to certain patterns or backgrounds on a television screen or while playing video games may induce an epileptic seizure in these individuals. Certain conditions may induce undetected epileptic symptoms even in persons who have no history of prior seizures or epilepsy. If you, or anyone in your family, has an epileptic condition, consult your physician prior to playing. If you experience any of the following symptoms while playing a video game—dizziness, altered vision, eye or muscle twitches, loss of awareness, disorientation, any involuntary movement, or convulsions—IMMEDIATELY discontinue use and consult your physician before resuming play.

Contents: Sewer Shark™

Getting Started

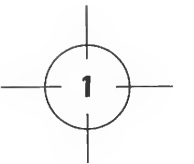

Summary of Game Controls

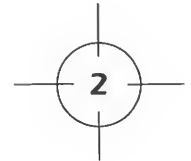

From The Desk of Commissioner Stenchler

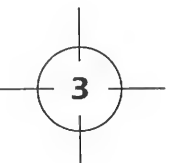

Meet Your Crew, Dogmeat!

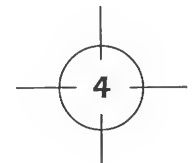

In the Cockpit

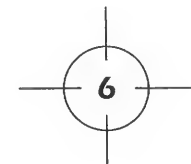

Shoot the Tubes, Dogmeat!

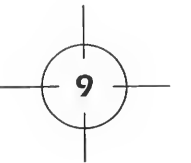

What The @\$%&*! Is That?

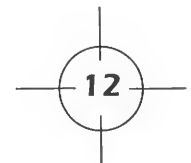

A Message From Your Old Mentor

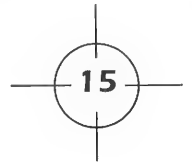

A Glossary of Sewer Speak

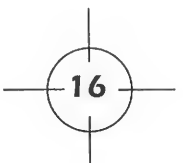

Limited Warranty

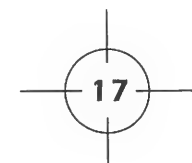

GETTING STARTED

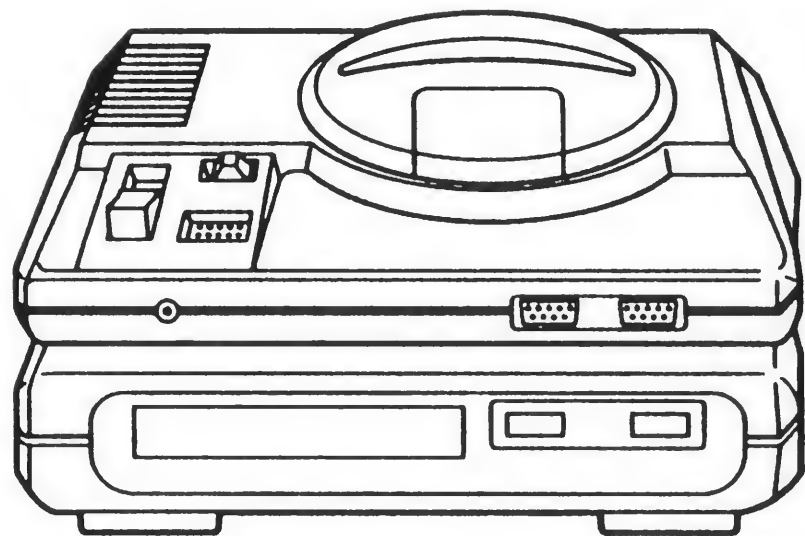

1. Genesis Controller should be plugged into the "Control 1" on your Sega Genesis.
2. For Audio: Using the cable on the Sega CD, attach head phones output-jack on the Sega Genesis to the mixing jack.
3. Follow Sega CD System directions to OPEN the Sega CD drive from the Sega CD Control Menu.
4. Carefully place your Sewer Shark™ CD game disc in the Sega CD System with the label-side facing up.
5. CLOSE the Sega CD drive from the Sega CD Control Menu and then select CD-ROM on the Control Menu to launch Sewer Shark and begin play.
6. Make sure that there is no game cartridge in your Sega Genesis System and follow all Sega CD System directions to activate your Sega CD System.

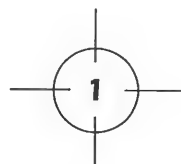

Summary of Game Controls

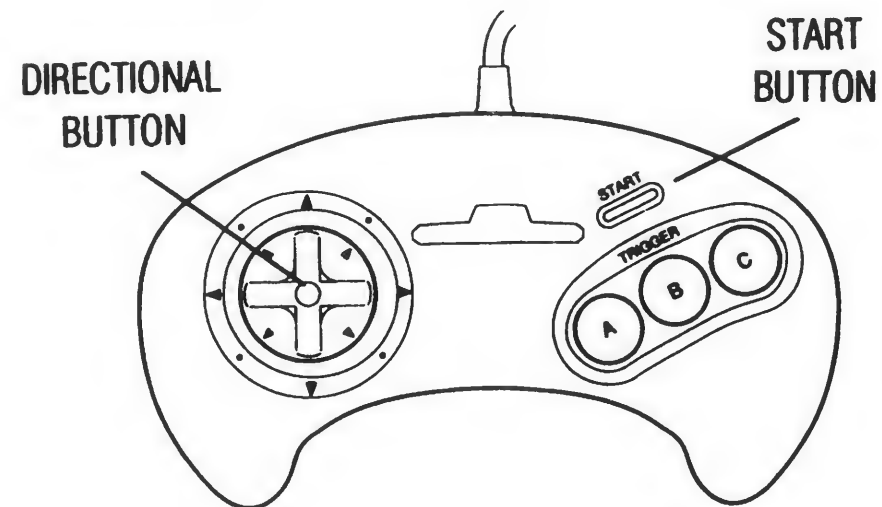

This game manual refers to the following directions for the D PAD on your Genesis Controller:

Here's a summary of game controls for Sewer Shark:

A BUTTON:

Fire your vehicle-mounted gun at cross-hair target

B BUTTON:

Turn D-PAD Steering Controls ON

C BUTTON:

Shoot off hydrogen flares (Only active when your Hydrogen Gauge is in the red "Danger Level")

D PAD (With Steering Controls OFF):

Aim the Gatling Gun crosshair

D PAD (With Steering Controls ON):

Steer Vehicle Through Directed Tube Jumps and Recharge Stations

START BUTTON:

Bypasses introductory sequence.
Pauses the game.

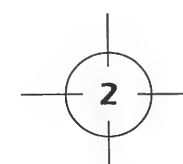

From: Commissioner Stenchler
Attn: Dogmeat
Re: Flight Manual/Assignment Orders

O.K. Junior Jock, listen up:

I know...I know...those hot-shots at TopRat got you all wound up thinkin' you're the best Sewer Jockey to ever Shoot the Tubes. Well, let me tell you somethin' Mr. Big-head, down here we got no fancy-pants high-tech simulators where you can hit the wall over and over and just say, "Ooops, sorry teacher...Can I try again?" Down here it's life and death pal! You I don't care about...you can be replaced. But if you so much as put a single scratch on one of my Sewer Sharks, I'll...I'll...well, you'll just have to wait and see what I do. But believe you me buddy boy, it won't be good. So get out there and clean up my sewers. I'm gettin' reports of vermin runnin' all up and down my sewers like they owned 'em. HEY, I OWN THEM SEWERS! And if I didn't have pressing administrative duties up here in Solar City, I'd be down there blastin' some ratigators myself. But I'm stuck with hotdogs like you tryin' to do a man's job.

Guess what? I'm gonna make it worth your while to get them sewers clean. Blast me a million pounds of sewer vermin and you'll earn your way to Solar City. Rumor has it Super Jock Falco's been seen up here sippin' banana fizzies with her toes in the sand. Come and rescue her, Pal. Dream on, Dogbreath - No Sewer Jock's ever made it this far, anyway.

But I betcha you think you're gonna be the first...ya!...and I got a T-Bone and a cold one just waitin' for you. Not!

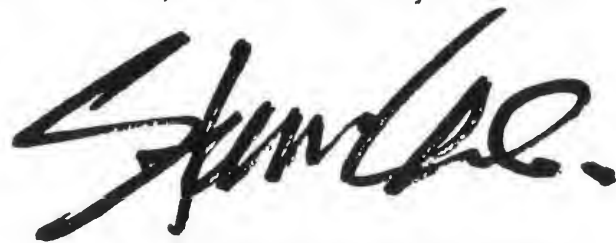

Commisioner Stenchler

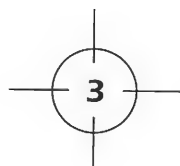

Meet Your Crew, Dogmeat!

Mission Assignment Date:

Immediate! Tour length undetermined.

Ghost (see glossary):

Ghost will be your co-pilot. Listen to him, Dogmeat. He's an Ace Jock with an attitude and a service rating of 98.9.

Your Call Sign:

To be assigned by Back-Seat, based on performance.

Hole Hawg:

Here's your ride! Boy, ain't she a beaut.

The Hole Hawg is a customized Exterminator Class Sewer Shark equipped with hydrogen flares and a Recon Probe Com Link. As you make your way further through the tubes, you can pick up a pair of Thompson super chargers on the thruster coils and "Sweet little 16," a rambunctious power blaster with a hearty magazine and a penchant for blastin' sewer scum.

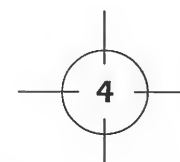
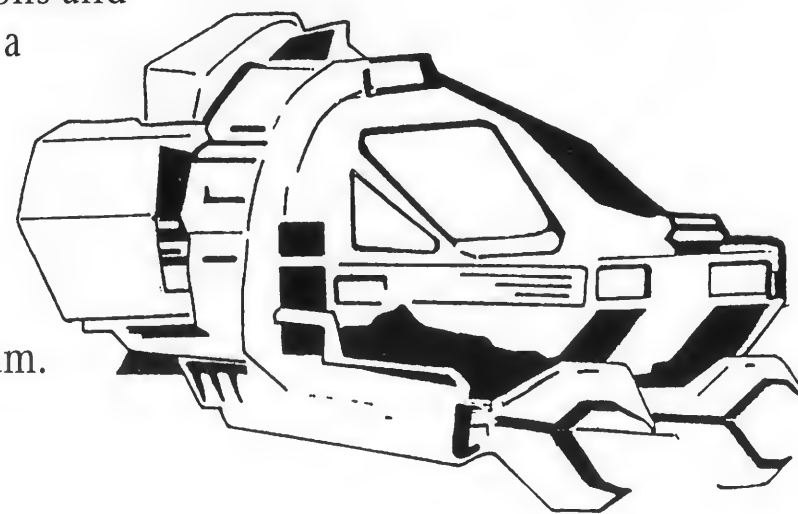

Catfish:

Catfish will be your guide.

He will be your eyes and ears on this mission. He's the best when it comes to target location and navigational assistance. Lose him and they'll be using Handiwipes to clean you off the walls.

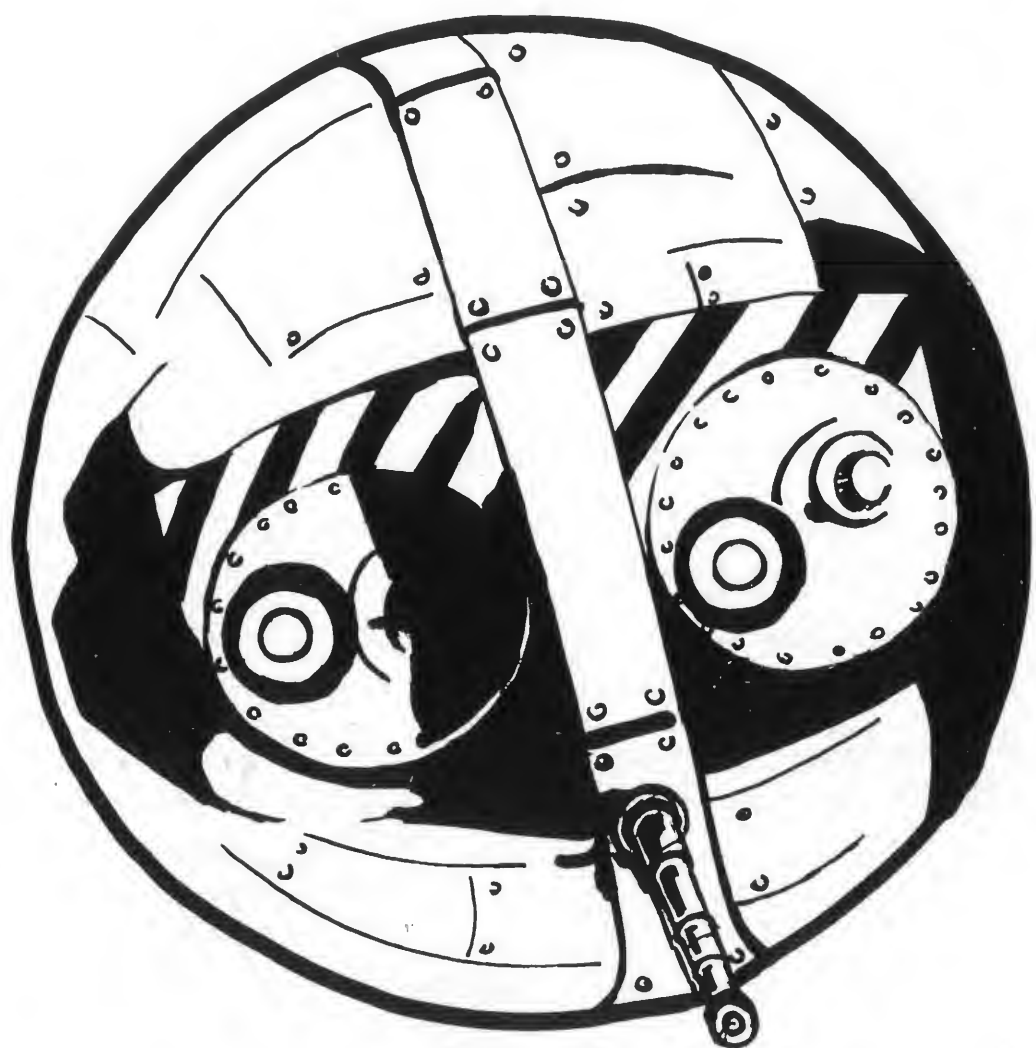

In the Cockpit

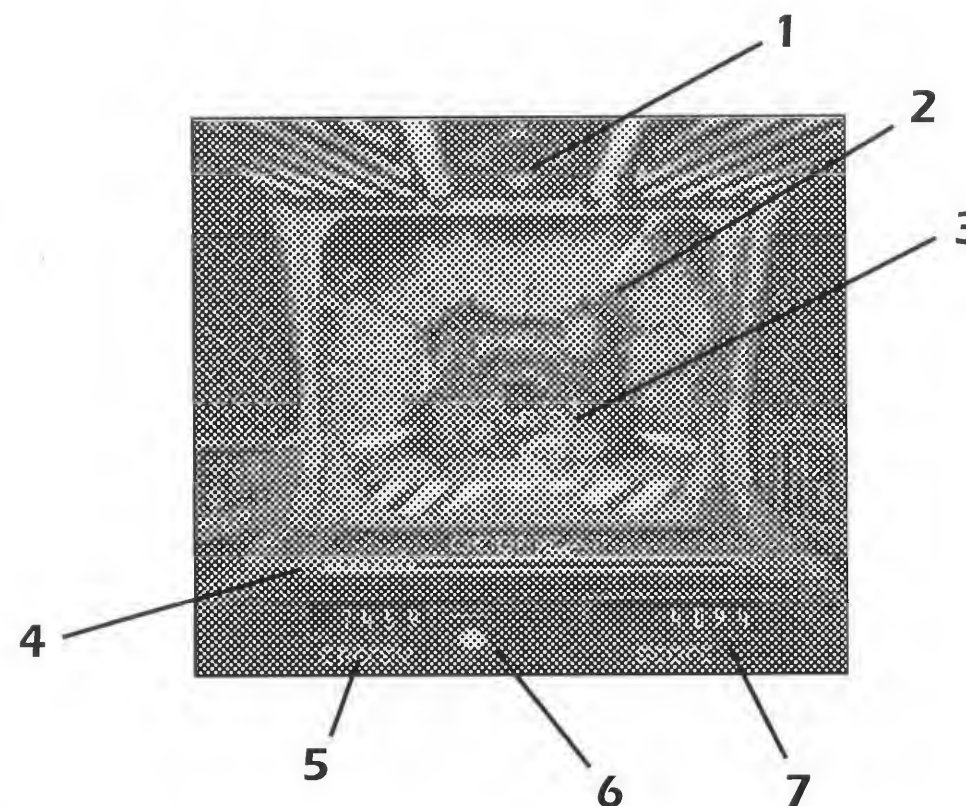

Heads-Up Screen

1 Tube Jump Indicator

As you approach any Tube intersection, the indicator arrows will light up to let you know the directions of upcoming Tubes, and the locations of available Tube Jumps. Even though a turn is available, it may not be the best way to go. Watch out!

The arrows represent the clockface navigational directions you will hear from Catfish: "Twelve O'clock (UP), Three (RIGHT), Six (DOWN), and Niner (LEFT)."

2 Display

This is your view of approaching tunnels and targets.

3 Targeting Crosshair

The crosshair aims your Gatling Gun at the various targets.

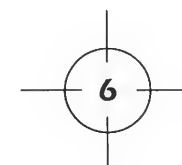
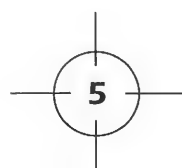

4 Hydrogen Indicator

This indicator tracks the hydrogen levels outside the Hole Hawg. As you travel deeper into the sewers, the hydrogen level will reach critical stage and the indicator will go red. When it does, you better fire a flare to explode the hydrogen in the Tubes ahead of you.

5 Energy Indicator

This number shows the Hole Hawg's remaining energy. Recharge as often as possible. If you run out of energy, you become rat food.

6 Com Line Signal

This light will flash whenever there is an incoming message on the com line. At this point, you will automatically switch to the Monitor Screen to view the incoming message.

7 Score Indicator

The number of pounds of sewer vermin you've killed is tracked here.

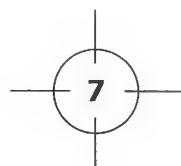

Monitor Screen

To receive an incoming com message, your view will automatically switch to the Monitor Screen, located on the Hole Hawg's dash, just below the Heads-Up Screen.

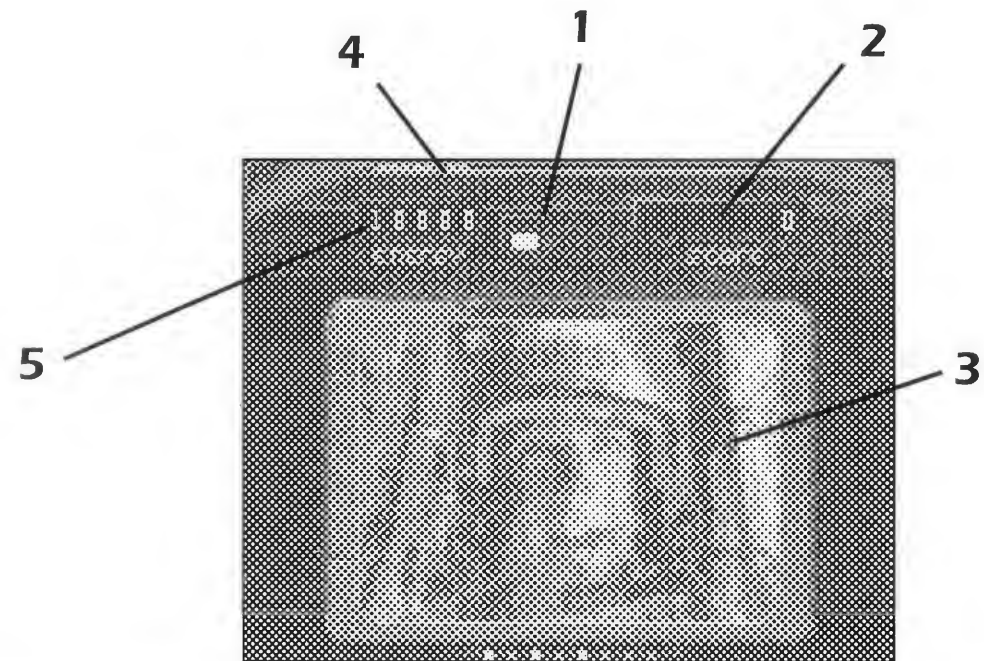

1 Com Line Signal

This light will flash when the incoming message is almost complete. After the com transmission, your view will automatically switch back to the Up Screen.

2 Score Indicator

3 Viewing Screen

You will view the incoming transmission on this Viewing Screen.

4 Hydrogen Indicator

5 Energy Indicator

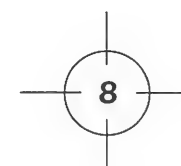

Shoot the Tubes, Dogmeat!

Blast that Vermin

To eradicate the various sewer-dwellers you'll encounter, aim the Targeting Crosshair over the little puke and fire.

CONTROLS

D PAD UP, DOWN, LEFT and RIGHT to move the crosshair.

A BUTTON to fire your Gatling Gun.

Make the Jump

Catfish is running recon for you ahead of the Hole Hawg. He's locating potential targets for you, and opening the sewer system's flow-hatch doors in your path.

At your rate of speed, you don't want to ride into a Tube where the hatch-door is closed—or it will be the last Tube you ride.

Catfish will signal you on the com line and give you navigational directions to target locations. Catfish will let you know the path where he's opened the hatch doors by calling out clockface directions—Twelve, Three, Six and Niner.

His directions are the Tube Jumps you need to make to follow him.

Catfish's directions will require you to make three consecutive Tube Jumps.

For example, he'll call out: "Three, Niner, Six." You must then make Tube Jumps at the three intersections immediately following his directions—first RIGHT (Three), then LEFT (Niner), then DOWN (Six).

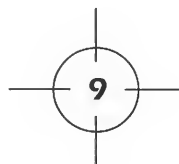

If you do not follow Catfish's directions exactly, he'll try his best to find you and open hatch doors ahead of your new course—but he won't always make it...and neither will you.

A flashing green light means you have an option to jump to another tube—you don't have to take it. To make a Tube Jump, you'll need to engage the Hole Hawg's Steering Controls, then Steer into the Tube you want. If, following a jump, the lights change to yellow, your jump is locked. If that light turns red, you've made the wrong turn or missed the correct turn.

CONTROLS

B BUTTON to activate the Steering Controls

D PAD UP, DOWN, LEFT and RIGHT to steer the Hole Hawg in the direction of the Tube Jump you need to make.

For Example, if Catfish calls out, "Twelve, Niner, Niner," your controls would be:

B BUTTON to activate Steering, then D PAD UP when you see the UP Arrow on the Tube Jump Indicator flashing; then

B BUTTON to activate Steering, then D PAD LEFT when you see the LEFT Arrow on the Tube Jump Indicator flashing; then

B BUTTON to activate Steering, then D PAD LEFT when you see the LEFT Arrow on the Tube Jump Indicator flashing. You know a turn is locked-in when the arrow turns yellow.

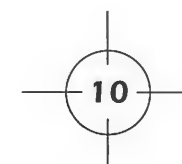

Get Charged Up!

Throughout the sewers there are Recharge Stations to power up the Hole Hawg.

Each Recharge Station has two entrances: LEFT and RIGHT.

Beware: only one of the two paths is active at any time.

You won't know which one is active until you approach it and check out the Active Charge Lights at the top of the tunnel.

The two lights on the Tube ceiling represent the two entrances to the Recharge Station. One will be green, the other red. The green light shows which path into the Recharge Station is open: LEFT or RIGHT.

Just because the light is red does not mean you can't go through that path—it simply means you won't recharge the Hole Hawg.

What The @#\$%&*! Is That?

After decades of ever-increasing toxins filtering through the sewer system, you see some pretty disgusting freaks of nature down in the Tubes.

Bats

Giant bats are everywhere in the sewer. They are a nuisance, but bring no harm to you if you miss them.

Average Weight:

200 lbs.

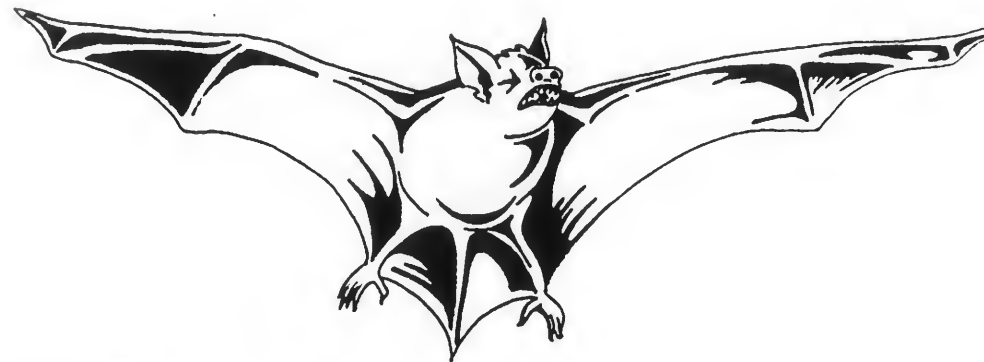

Ratigators

Ratigators are a snarling mutation of rats and sewer alligators. Fortunately, the Ratigator will not inflict damage on the Hole Hawg if you miss it.

Average Weight:

500 lbs.



Scorpions

Watch out for these guys. Gigantic Scorpions are far more aggressive than Bats or Ratigators. If you don't shoot them they will attack the Hole Hawg and drain your energy. Remember: To kill a Scorpion, you must hit it twice.

Average Weight:
2,000 lbs.

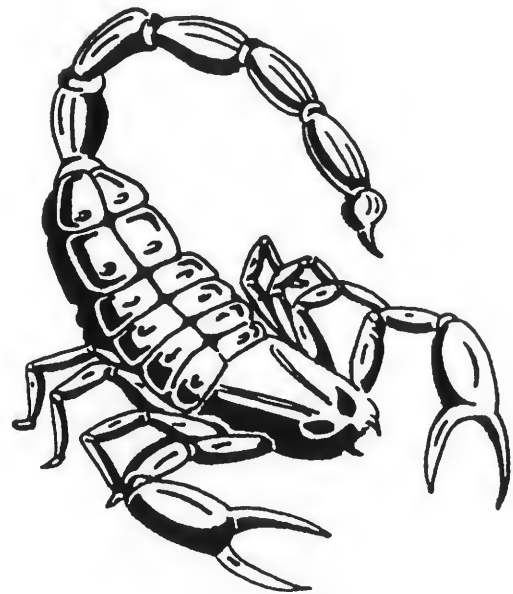

Moles

Heaven help you! Before Sewer Jockeys, the department used these automated Moles to keep the sewers clean. But they've gone renegade and will attack Sewer Sharks without warning. Moles have diamond-edged Skil saws and pointed battering rams for hands. If you encounter a Mole, it's him or you — only one vehicle will come out of the Tube in one piece. Remember: Hit a Mole once and you're in trouble.

Average Weight:
20,000 lbs.



Zerks

Zerks are dangerous strains of fireflies that live deep in the sewers and feed on hydrogen and power from Recharge Stations. Zerks have evolved into high-density energy forces and have been known to suck out the brains of any Sewer Jockey who crosses their path. To put it simply: Blast 'em or get an instant full-cranial lobotomy.

Average Weight:
50,000 lbs.

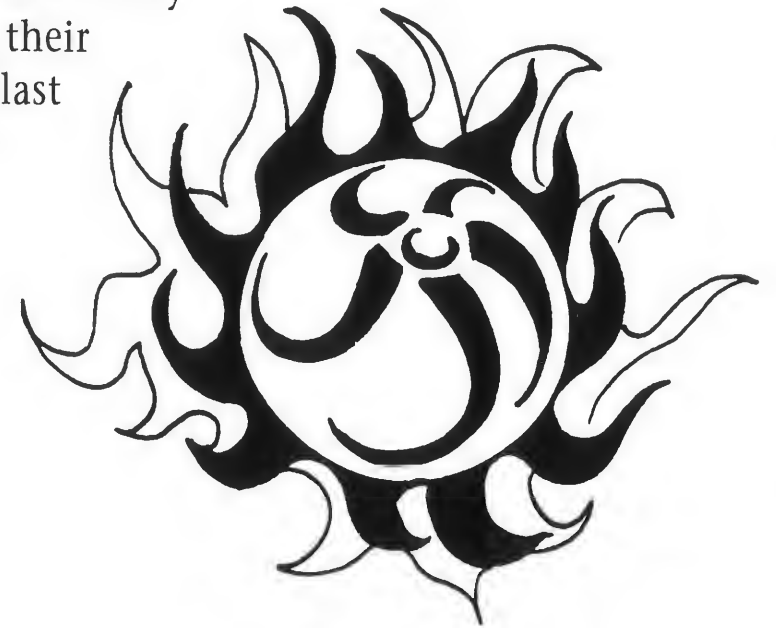

"The Crazy Looking Thing"

Recent reports from long-lost deep-dwelling Sewer Jocks mention a "Crazy Looking Thing" hanging out in the far reaches of the Tube. Its existence has yet to be confirmed, but the word is this "Thing" apparently showed no hostile signs—and they say it's been known to guide Jocks through the tunnels. He may be an ally, but until you can determine its nature and intentions, approach with caution.

Average Weight:
Unknown at this time



A Message From Your Old Mentor

In case you've forgotten all your training, rookie, here's a refresher course on TopRat's Top 10 Sewer Jockey rules:

1. Always listen to your Back-Seat.
2. Don't lose track of jump coordinates that Catfish gives you.
3. Keep track of your fellow Sewer Jocks.
4. Learn locations of Recharge Stations. They always change.
5. Feed your Sewer Shark as often as you can at Recharge Stations.
6. When facing two or more targets, always shoot the most dangerous one first.
7. Watch your hydrogen gauge and shoot your flare as soon as possible.
8. Don't get cocky.
9. Don't trust Stenchler.
10. When it gets really hairy down there, just picture yourself sitting on the beach in Solar City.

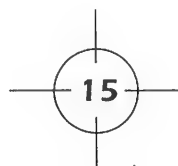

A Glossary of "Sewer Speak"

Eyes:	Catfish's recon camera
Backseat:	Your co-pilot and navigator, sitting behind you in the Sewer Shark
Hole Hawg:	Ghost's customized (not-entirely-legal) Sewer Shark
Jump:	Your move into a new tube
Mole:	Roaming maintenance robot that cleans debris from the sewers with a saw and probe
Ratigator:	A combination rat and alligator that inhabits the sewers
Sector 19:	A forbidden zone that holds many secrets and surprises—as well as extreme danger
Sewer Jockey:	Sewer Shark pilot
Sewer Shark:	The Municipal Sewer Department's Exterminator Class vehicle in which you'll shoot the tubes
Solar City:	An off-limits paradise up on the surface—sun, surf and sand. Top sewer jockeys are rewarded with a one-way ticket to Solar City...if they can find it...and make it there in one piece.
T/A:	Target acquisition or target sighted
TopRat:	Sewer Shark jockeys' elite flight-training school
Tubes:	Sewer tunnels
Twelve O'clock:	Navigational direction based on the clockface: Twelve—UP Three—RIGHT Six—DOWN Niner—LEFT
Up Screen:	The pilot's heads-up display
Zerks:	Brain-eating fireflies that infest the tubes

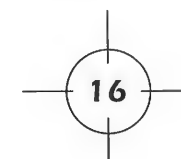

SONY IMAGESOFT INC. WARRANTY

Sony Imagesoft, Inc. warrants to the original purchaser of this Sony Imagesoft product that this CD Disc is free from defects in material and workmanship for a period of ninety (90) days from the date of purchase. This Sony Imagesoft product is sold "as is," without expressed or implied warranty of any kind, and Sony Imagesoft is not liable for any losses or damages of any kind resulting from the use of this product. Sony Imagesoft agrees for a period of ninety (90) days to either repair or replace, at its option, free of charge, the Sony Imagesoft product. Send product postage paid, along with dated proof of purchase, to the address shown below.

This warranty shall not be applicable and shall be void if the defect in the Sony Imagesoft product has arisen through abuse, unreasonable use, mistreatment or neglect. THIS WARRANTY IS IN LIEU OF ALL OTHER WARRANTIES AND NO OTHER REPRESENTATIONS OR CLAIMS OF ANY NATURE SHALL BE BINDING ON OR OBLIGATE SONY IMAGESOFT. ANY IMPLIED WARRANTIES APPLICABLE TO THIS SOFTWARE PRODUCT, INCLUDING WARRANTIES OF MERCHANTABILITY AND FITNESS FOR A PARTICULAR PURPOSE, ARE LIMITED TO THE NINETY (90) DAY PERIOD DESCRIBED ABOVE. IN NO EVENT WILL SONY IMAGESOFT BE LIABLE FOR INCIDENTAL OR CONSEQUENTIAL DAMAGES RESULTING FROM POSSESSION, USE OR MALFUNCTION OF THE SONY IMAGESOFT SOFTWARE PRODUCT.

Some states do not allow limitations as to how long an implied warranty lasts and/or exclusions or limitations of consequential damages, so the above limitations and/or exclusions of liability may not apply to you. This warranty gives you specific legal rights, and you may also have other rights which vary from state to state.



Sony Imagesoft, Inc.
9200 Sunset Blvd., Suite 820
Los Angeles, CA 90069

Patents: U.S. Nos. 4,442,486/4,454,594/4,462,076; Europe No. 80244; Canada No. 1,183,276; Hong Kong No. 88-4302; Singapore No. 88-155; Japan No. 82-205605 (Pending)

Digital Pictures



LICENSED BY SEGA OF AMERICA, INC.
FOR PLAY ON THE SEGA CD™ SYSTEM.

Sewer Shark is distributed by Sony Imagesoft, 9200
Sunset Boulevard, Suite 820, Los Angeles, California
90069. Sewer Shark developed for Sony Imagesoft by
Digital Pictures, Inc. © 1992 Digital Pictures, Inc. All
rights reserved. Sewer Shark is a trademark of Hasbro,
Inc. Sony Imagesoft and Imagesoft are trademarks of
Sony Electronic Publishing Company.

SONY



IMAGESOFT™

Sony Imagesoft Inc.
9200 Sunset Blvd., Suite 820
Los Angeles, CA 90069

SEGA AND SEGA CD ARE TRADEMARKS
OF SEGA ENTERPRISES, LTD. ALL RIGHTS
RESERVED.

Printed in the USA